

NÁVOD NA MONTÁŽ AK-305

40 min

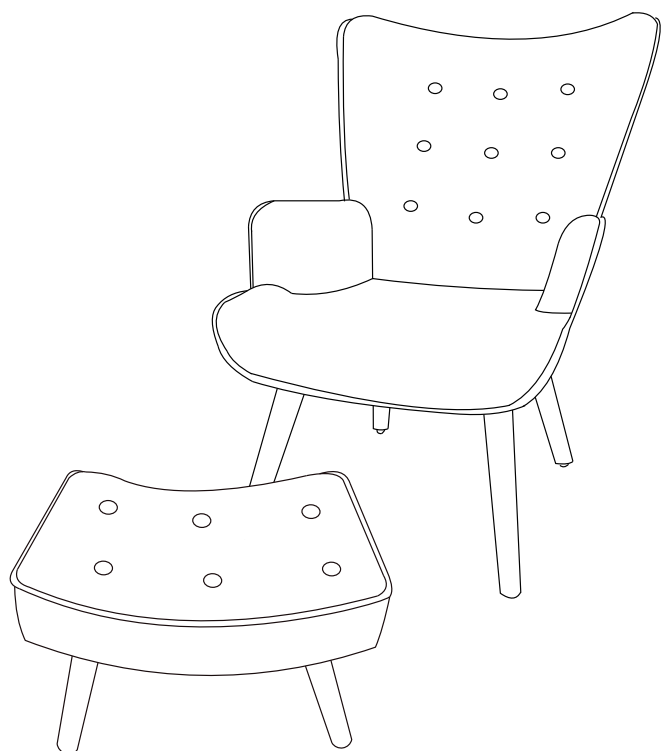

2 x



⚠ Gz MONTÁŽNÍ POKYNY

1. Pečlivě ověřte, zda díly před montáží nechybí nebo nejsou poškozené.
2. Při montáži dejte pozor na přítomnost dětí, aby nedošlo k vdechnutí, spolknutí malých dílů nebo poranění.
3. Šrouby během instalace neutahujte. Po instalaci všech šroubů je rovnoměrně utáhněte.

POKYNY K POUŽÍVÁNÍ

1. K čištění používejte pouze měkký hadřík a prostředky k tomu určené.
2. Nepoužívejte na místech s nadměrným výskytem vlhkosti nebo teploty.
3. Při používání křesla s taburetem **nesed'te** pouze v přední části nebo jen v jeho polovině a křeslo a taburet nepřetěžujte.
4. Nesedějte na křeslo v opačném směru, ani na něj i taburet **nestoupejte**.
5. Nepoužívejte křeslo a taburet k jinému účelu, než je určeno.

⚠ Sk MONTÁŽNE POKYNY

1. Starostlivo overte, či diely pred montážou nechýbajú alebo nie sú poškodené.
2. Pri montáži dajte pozor na prítomnosť detí, aby nedošlo k vdýchnutiu, prehltnutiu malých dielov alebo poraneniu.
3. **Skrutky počas inštalácie neťahujte. Po inštalácii všetkých skrutiek ich rovnomerne utiahnite.**

POKYNY NA POUŽÍVANIE

1. Na čistenie používajte iba mäkkú handričku a prostriedky na to určené.
2. Nepoužívajte na miestach s nadmerným výskytem vlhkosti alebo teploty.
3. Pri používaní křesla s taburetom **nesed'te** iba v prednej části alebo len v jeho polovici a křeslo aj taburet nepřetěžujte.
4. Nesadajte na křeslo v opačnom směru, ani na neho aj taburet **nestúpajte**.
5. Nepoužívejte křeslo a taburet na iný účel, než je určeno.

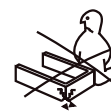
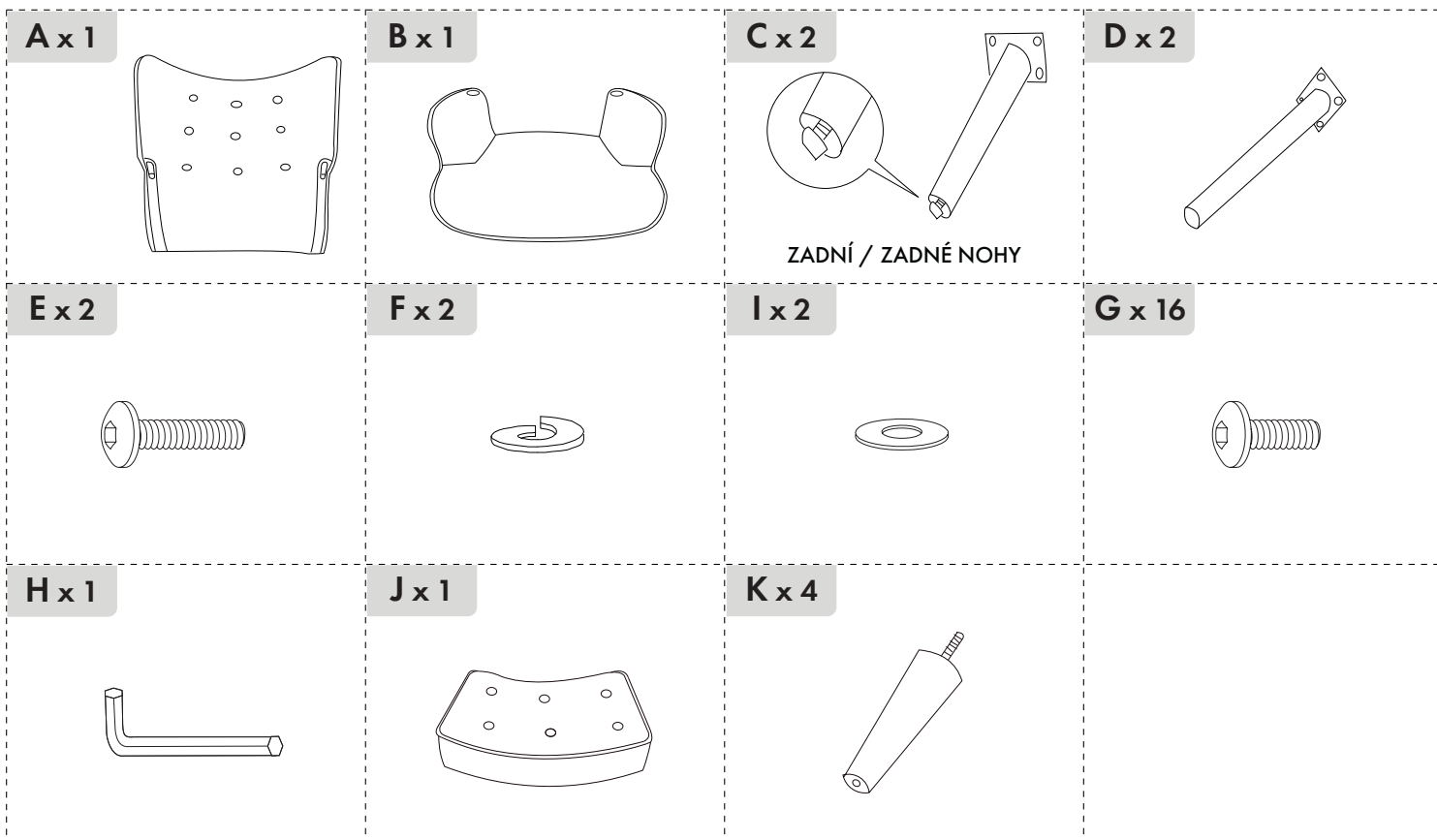

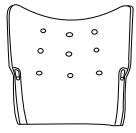
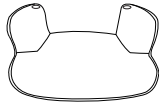
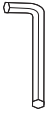
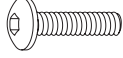
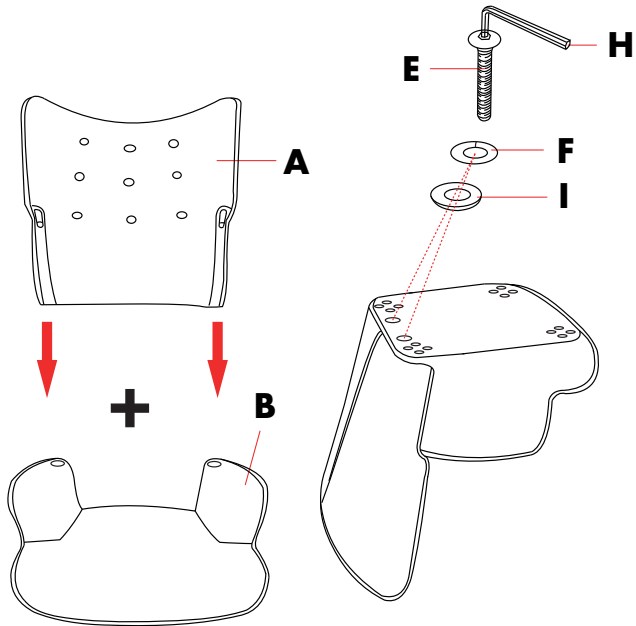
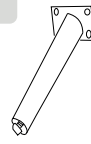
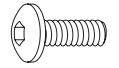
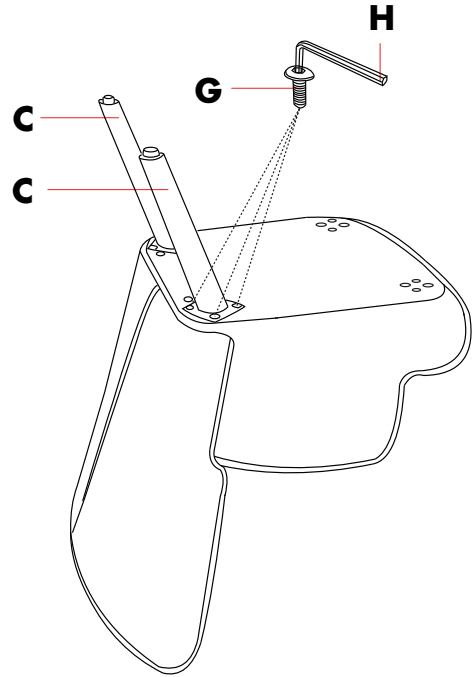
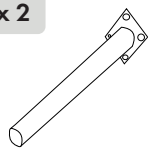
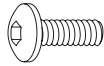
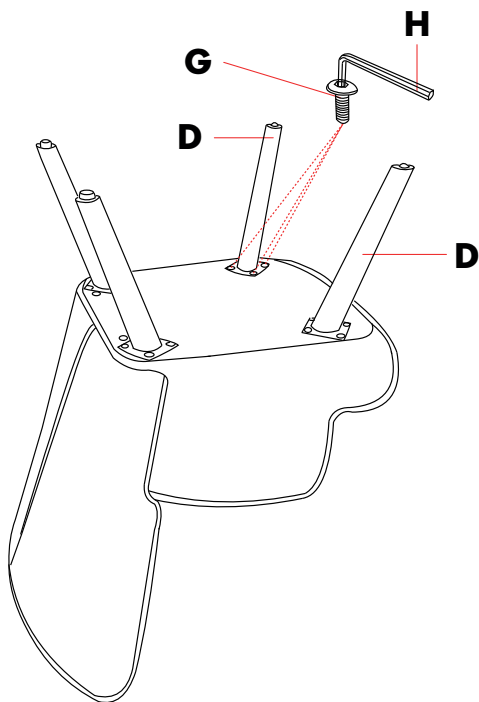
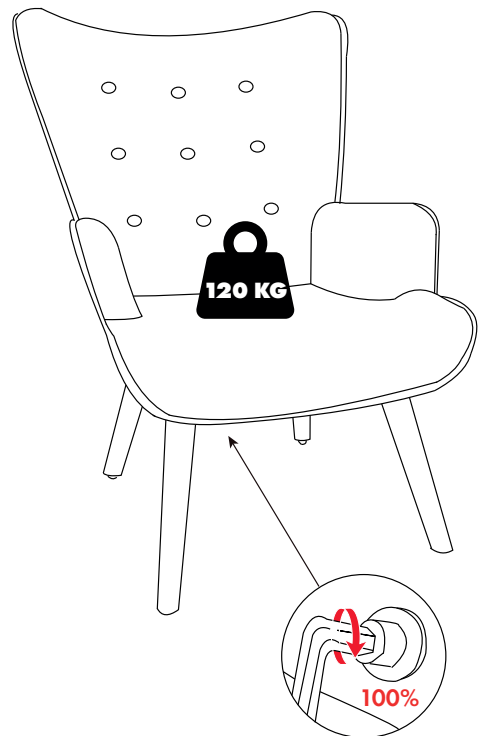
1**A x 1****B x 1****H****E x 2****F x 2****I x 2****2****C x 2****G x 8****H****3****D x 2****G x 8****H****4**

5

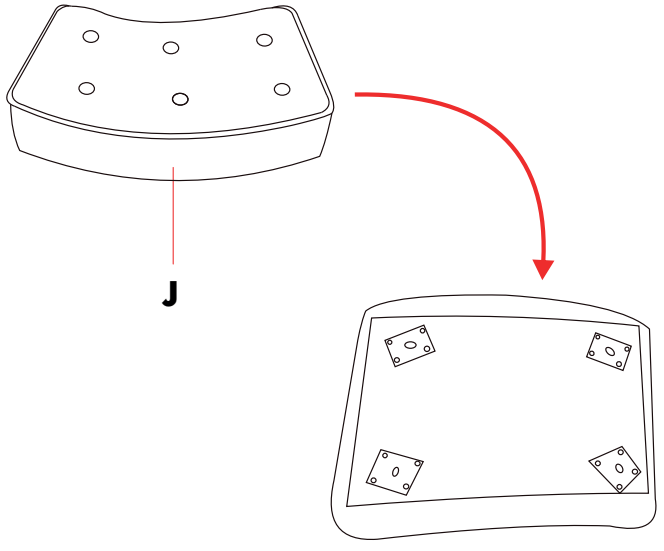
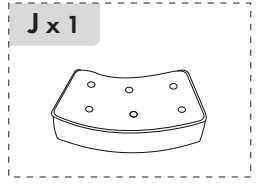

6

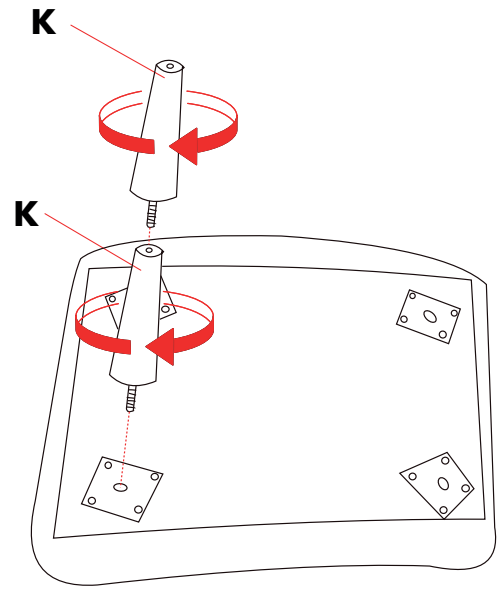
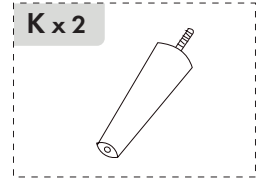

7

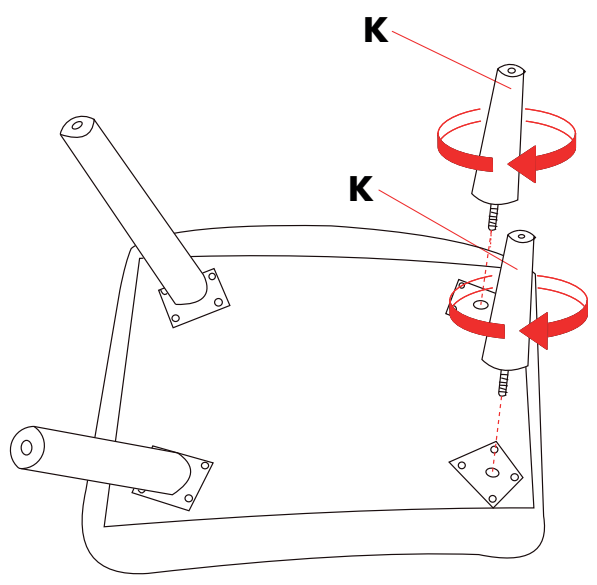
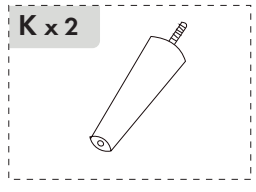

8

